

# DENAFRIPS

TERMINATOR 15th user's manual

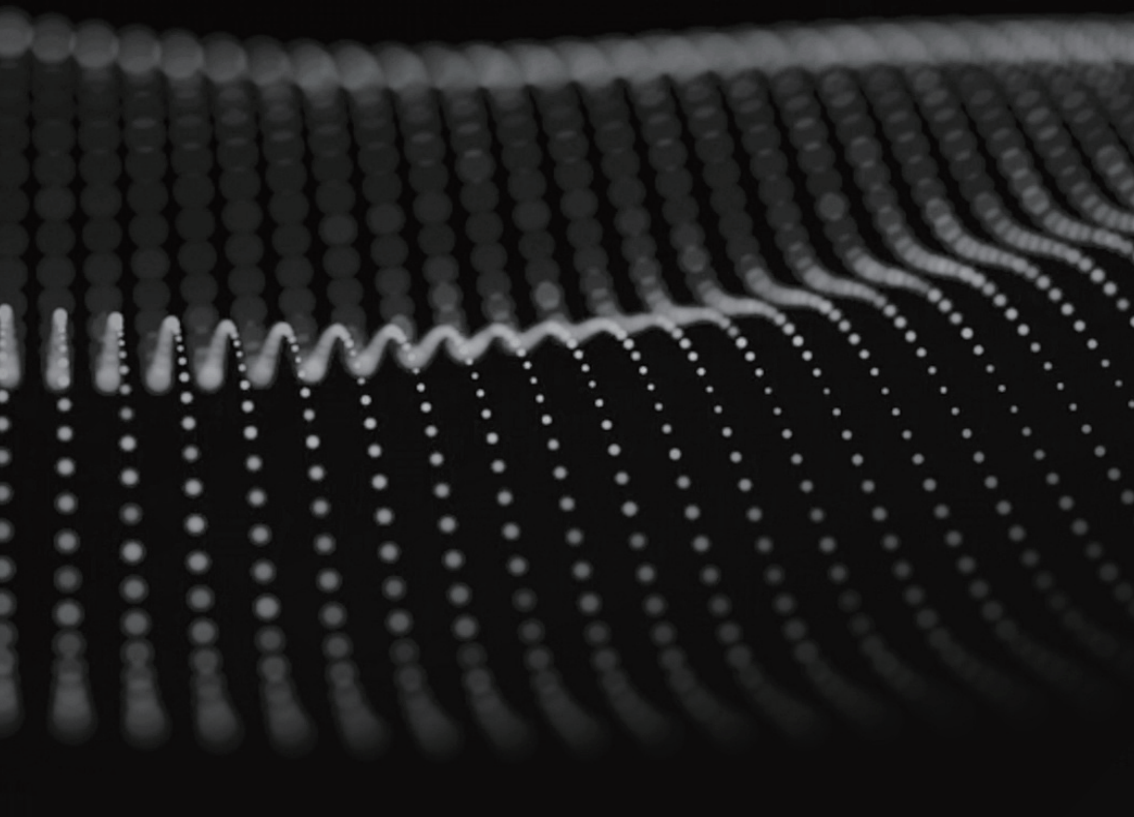

# Table of Contents

- Product Overview .....3
- Function Panel Introduction .....7
- Backplane Interface Introduction .....9
- Technical specification ..... 10
- Operation Settings ..... 12
- USB Driver Installation ..... 18
- Common Troubleshooting..... 19
- After-sales service..... 21
- Important protective measures to note ..... 22

Since its inception, the TERMINATOR series has been favored by music lovers for its excellent price/performance ratio and outstanding sound quality. The TERMINATOR 15th, the third iteration of the series, raises this benchmark to a new level. The upgrade focuses on a number of significant optimizations in terms of internal construction and sound performance.

## **1. Internal architecture and circuit optimization**

The TERMINATOR 15th has been significantly optimized in terms of architecture, especially in terms of R2R architecture and circuit design. The use of fully balanced R2R circuits and high-speed multi-channel digital isolators ensures more accurate digital-to-analog signal conversion. The combination of multiple R2R array resistors and triggers achieves extreme accuracy during signal transmission, resulting in even better sound quality performance. In addition, the dual power supply system with a high-quality LDO chip ensures power stability and further enhances signal transmission efficiency and reliability.

## **2. Precise clock system and power supply design**

To ensure the accuracy of the clock, TERMINATOR 15th designed a separate clock board with two special high-precision customized thermostatic crystals, along with a separate shielded box and gold screws, which provide protection for the clock signals as well as enhance the overall stability of the device. These design details ensure the proper operation and high efficiency of the FPGA algorithms, enabling them to accurately handle multiple sample rates and audio formats.

In terms of power supply design, the TERMINATOR 15th utilizes dual O-shape transformers, dual power supply rectifier filter circuits and high-quality WIMA and EPCOS capacitors to completely isolate interference between power supplies, further improving the purity of sound quality and the durability of the unit.

### **3. Sound quality performance**

The TERMINATOR 15th is particularly good in terms of sound quality. The low-frequency part is elastic and powerful, the mid-frequency performance is full, and can truly restore the details and layers of music; the high-frequency part is transparent and natural, without the slightest sense of sharpness, which is suitable for a long time listening. This delicate and balanced sound quality makes the TERMINATOR 15th show excellent performance in a variety of music styles, whether it is the delicate performance of classical music or the low-frequency energy of electronic music, all can be fully reflected.

### **4. Product List**

If you do not purchase additional products, when you receive the goods, the package only contains the machine itself, without the power cord and remote control.

## Functional Features

- ①. Proprietary R2R architecture.
- ②. True fully balanced 26bit R2R + 6bit DSD (32 stage FIR filter).
- ③. Multiple high-precision resistors are used in the R2R line.
- ④. Special 45.1584MHz, 49.152Mhz high-precision active crystal with low phase noise.
- ⑤. Adaptive FIFO clock buffer.
- ⑥. Optimized FPGA digital signal processing algorithm.
- ⑦. USB and I2S input audio source sample rate up to DSD1024, PCM1536KHz.
- ⑧. USB audio solution is realized by high-speed ARM MCU.
- ⑨. Licensed Thesycon USB driver for Windows platform.
- ⑩. No driver is required for Mac and Linux.
- ⑪. 7 types of digital input sources, of which AES can be humanized to single & dual AES input mode.
- ⑫. Fast/slow roll-off filter is selectable.
- ⑬. The I2S input pin has 8 modes to choose from, which is perfectly compatible with all major brands of audio sources and DDC devices on the market.
- ⑭. When I2S plays DSD signals, you can swap the left and right channels through the function settings.
- ⑮. Digital reception processing and R2R circuit part, each adopts a toroidal transformer to provide superb power supply capability, and adopts multiple low-noise LDOs.
- ⑯. The unit has customized high quality electrolytic capacitors, and a variety of incoming complementary film capacitors.

## DSD

- ①. OPT, COAX, AES support DSD64–DoP.
- ②. USB and I2S inputs support up to DSD1024.

## PCM

- ①. OPT, COAX, AES support 44.1KHz–192KHz.
- ②. USB input supports 44.1KHz–1536KHz.
- ③. I2S input supports 44.1KHz–768KHz.

## sampling mode

Original Bit Rate NOS/Oversampling OS

## clock output

- ①. Support: 45.4584MHz clock output
- ②. Support: 49.152MHz clock output

# Function Panel Introduction

Figure 1

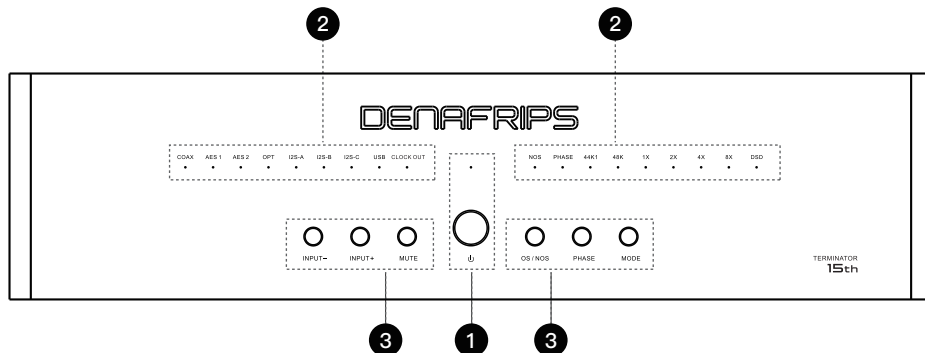

## ①. Standby buttons and indicators

When the power of the unit is turned on, the standby indicator light is on, indicating that it is in standby mode. Press the standby button, the standby indicator goes off and the DAC starts to work.

## ②. Indicators on the DAC panel (showing input source, sample rate, octave, audio format and mode).

- Signal source indicators: COAX, AES 1, AES 2, OPT, I2S-A, I2S-B, I2S-C, USB. These indicators indicate the different input ports. When an input source is selected, the corresponding indicator lights up.
- Sample rate indicator: 44.1K (44.1 KHz sample rate); 48K (48 KHz sample rate). These indicators indicate the current sample rate of the input audio signal.
- Multiplier Indicators: 1X (original sample rate); 2X (2 times the sample rate); 4X (4 times the sample rate); 8X (8 times the sample rate). These indicators indicate the current multiplier frequency of the input audio signal (e.g., a multiple of the original sample rate, as described in the chart below).
- Audio format indicator: DSD when the light is on, PCM when the light is off.
- OS/NOS indicator: NOS when the light is on, OS when the light is off.

In OS mode, the DAC processes the incoming digital audio signal to increase the sampling rate.

Oversampling improves audio quality by adding more data points through interpolation algorithms.

In NOS mode, the DAC processes the input digital audio signal directly without any sample rate processing. This mode preserves the original characteristics of the audio signal.

f. PHASE indicator: in-phase when the light is on, inverted when the light is off.

g. CLOCK OUT indicator: When the light is on, it indicates that the DAC is outputting clock signals. These clock signals can be used to synchronize other audio devices. This ensures that all devices are using the same clock source, thus reducing jitter and other timing problems and improving the overall performance of the audio system.

### ③. control key

a. INPUT-, INPUT+, PHASE, OS/NOS, MUTE, MODE. press these buttons for direct control of the audio input source, phase, sample mode, mute, and operating mode.

b. Description of each key

INPUT- button: Selects or switches to the previous input source.

INPUT+ button: Selects or switches to the next input source.

PHASE button: Phase selector switch, when this button is pressed, the PHASE lamp in Fig. 1 will be on for in-phase output and off for inverted output.

OS/NOS button: Source and oversampling selection on/off button, when this button is pressed, the NOS lamp in Figure 1 will be NOS when it is on, and OS when it is off.

MUTE button: When this button is pressed, all source indicators flash.

MODE button: Used to switch between different preset modes.



# Backplane Interface Introduction

Figure 3

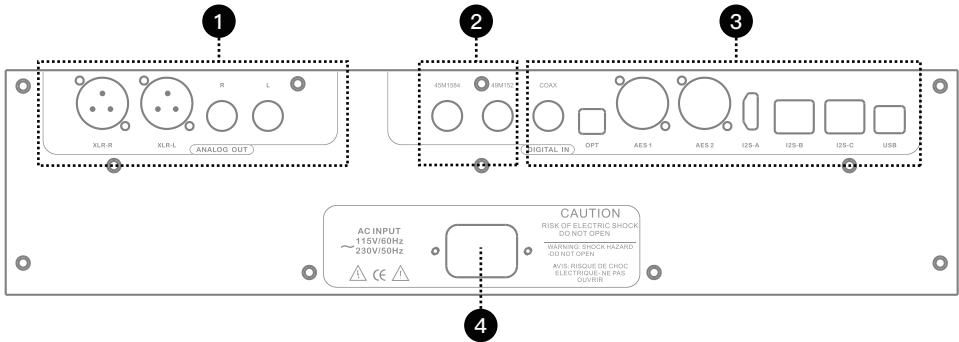

**❶. Analog audio signal output area, this unit has a pair of XLR outputs, a pair of RCA outputs, according to your equipment, choose the appropriate output.**

XLR-R: Analog signal right channel balanced output. XLR-L: Analog signal left channel balanced output.

RCA-R: Unbalanced right channel analog signal output.

RCA-L: Unbalanced left channel analog signal output.

Note: The outputs of the RCAs are connected in parallel to the positive end of the XLRs. In order not to affect your listening experience, we do not recommend that you use both the RCA and XLR outputs at the same time.

**❷. Clock Output Interface**

45M1584 and 49M152: Clock output interfaces for synchronization and transmission of high-precision clock signals. Synchronization of clock signals is essential to reduce jitter and improve audio quality. Clock synchronization between different devices ensures that digital audio signals remain consistent during transmission and processing, reducing signal distortion.

**❸. Digital Audio Input Interface**

There are a total of 8 input interfaces, namely COAX, OPT, AES 1, AES 2, I2S-A, I2S-B, I2S-C, and USB.

COAX: (Coaxial) digital interface, interface transmission is stable, suitable for short distance connection, provides high audio quality.

AES1: Digital balanced input connector, input impedance 110 ohms (the unit can be set up as a single-mode input or as a dual-mode input, see the above function setup description method for details).

AES2: Digital balanced input connector, input impedance 110 ohms (the unit can be set up as a single-mode input or as a dual-mode input, see the above function setup description method for details).

# Technical specification

Figure 2

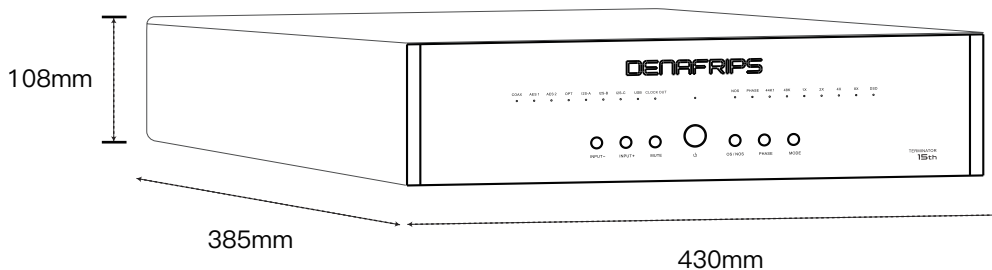

(OPT Input Test)

Analog Output:	RCA at 2.2Vrms, 625Ω
	XLR at 4.4Vrms, 1250Ω
Frequency Response:	20Hz–40KHz (+1/–0.2dB)
Distortion:	< 0.002%(A-weighting)
Signal-to-noise ratio:	≥120dB(A-weighting)
Dynamic Range:	≥132dB
Stereo crosstalk:	≥–110dB
AC Power Requirements:	115V/60Hz 230V/50Hz (Global voltage, automatic selection)
Power Consumption:	≤20W
Machine Dimensions:	430W x 385D x 108H mm(Includes feet)
Outer package dimensions:	610x 570 x 275 mm
Package Contents:	Electronic manual and warranty card
Net weight:	18.75 kg

The relationship between the sampling rate of the input audio signal and the display of the panel indicators is shown in Table 1 below.

Basic Sampling Rate	multiplier	input format
44.1 KHz	1X	44.1 KHz
	2X	88.2 KHz
	4X	176.4 KHz
	8X	352.8 KHz
	$16X = 2X + 8X$	705.6 KHz
	$32X = 4X + 8X$	1411.2 KHz
48 KHz	1X	48 KHz
	2X	96 KHz
	4X	192 KHz
	8X	384 KHz
	$16X = 2X + 8X$	768 KHz
	$32X = 4X + 8X$	1536 KHz
DSD	1X	DSD 64
	2X	DSD 128
	4X	DSD 256
	8X	DSD 512
	$16X = 2X + 8X$	DSD 1024

# Operation Settings

Function Setting	procedure
A. USB upgrade settings	<ol style="list-style-type: none"><li>1. Please download the USB upgrade firmware from the official website first, open the storage location on your computer and find the ****.bat file.</li><li>2. Let the machine connected to the mains and in standby mode, only the standby light is on.</li><li>3. Connect one end of the USB cable to your computer and one end to the machine's USB audio source.</li><li>4. Open the **.bat file on your computer and the upgrade screen will appear.</li><li>5. In standby mode, press the “Mode” button to select USB input, the “USB” audio source indicator flashes, indicating that it is upgrading the firmware. When the USB firmware is upgraded successfully, there will be the words “Firmware burned successfully” on the computer interface.</li><li>6. Unplug the power cord, plug the power cord again, the machine is in standby mode, press the standby button, the machine starts up, press the MODE button, the USB firmware will be upgraded successfully.</li></ol>
B. Dual AES inputs	<ol style="list-style-type: none"><li>1. The audio source is selected at AES1 or AES2.</li><li>2. Press the MUTE button to enter configuration mode.</li><li>3. Toggle INPUT+ button instantly (within 2s) AES1 lamp on = Dual AES mode; AES2 off = single mode;</li><li>4. wait 10 seconds.</li><li>5. The DAC's AES mode is successfully set and all other functions are restored to their original state.</li></ol>

Function Setting	procedure
<p>C. Filter Selection (valid only in the operating system)</p>	<ol style="list-style-type: none"> <li>1. Press the MUTE button to enter configuration mode.</li> <li>2. Switch the PHASE button momentarily (within 2s)  1X lamp on, 8X lamp on = slow filter  1X lamp off, 8X lamp on = fast filter</li> <li>3. Wait 10 seconds.</li> <li>4. DAC filter is set successfully and all other functions are restored to their original state.</li> </ol>
<p>D. Clock output function setting</p>	<ol style="list-style-type: none"> <li>1. Press the MUTE button to enter configuration mode.</li> <li>2. INPUT-button to enter clock output function setting</li> <li>3. No lamps will light when there is no clock output, and the CLOCKOUT lamp and the lamp corresponding to the clock will light when there is clock output;  CLOCK OUT lamp lights + C0AX lamp lights = output word clock with the same sampling rate as the input signal.  CLOCK OUT + AES1 = output word clock;  CLOCK OUT lamp on + AES2 lamp on = output half of the master clock;  CLOCK OUT lighted + OPT lighted = output master clock;</li> </ol>
<p>E. Selection Oversampling Rate / Original code rate</p>	<ol style="list-style-type: none"> <li>1. Press the OS/NOS button</li> <li>2. NOS indicator on = original code rate,  NOS indicator off = oversampling rate</li> </ol>
<p>F. Sound Source Selection</p>	<p>COAX, OPT, AES 1, AES 2, I2S-A, I2S-B, I2S-C and USB.  Press these buttons to select the input source and the corresponding source indicator will light up.If a device has more than one audio source input, press the corresponding audio source input button and the indicator lights up to indicate successful switching.</p>

Function Setting	procedure
<p>G. I2S DSD Channel Switching Configuration</p>	<ol style="list-style-type: none"> <li>1. Select the I2S–A input</li> <li>2. Press the MUTE button to enter configuration mode.</li> <li>3. Switch the NOS button momentarily (within 2s) to realize DSD left and right channel swap. <ul style="list-style-type: none"> <li>– COAX light on means L/R</li> <li>– AES1 light on means R/L</li> </ul> </li> <li>4. Wait for 10 seconds.</li> <li>5. DAC returns to its original state.</li> </ol>
<p>H. I2S Pin Configuration (Note: configure the pins after turning down the volume)</p>	<p>Key: Please first determine the I2S PINOUT pinout diagram, and then determine what kind of wire sequence mode in the 1–8 modes of the I2S in the following figure (the LEDs indicate binary 000–111, “○” indicates that the light is off and “●” indicates that the light is on), and pay attention to the 3 lights on and off. Note that the three lights are on and off, and the machine is factory configured for mode “1” state.</p> <ol style="list-style-type: none"> <li>1. Select I2S Input</li> <li>2. Press the MUTE button to enter the configuration mode.</li> <li>3. After pressing PHASE button momentarily (within 2s), the 1X , 2X , 4X lamps will be on/off, after pressing PHASE button repeatedly again, these 3 lamps will be on/off in a fixed mode, you can stop the operation immediately after selecting the required matching mode (see I2S pin diagram for details), if you miss the required mode, follow the above steps to do it again.</li> <li>4. Wait for 10 seconds.</li> <li>5. The I2S setting of DAC is successful, and other functions are restored to their original state.</li> </ol>

**Table 2: I2S Pin Diagram (The machine is shipped in mode ‘1’, all lamps are off, ‘○’ = lamps off, ‘●’ = lamps on)**

Mode	LED on & off Relationship Diagram			I2S PINOUT						
	1X	2X	4X	PIN	DATA		BCK		LRCK	g
1	DATA	BCK	LRCK	Mode	1	3	4	6	7	
2	○	○	○	1	DATA-	DATA+	BCK+	BCK-	LRCK-	LRCK+
3	●	○	○	2	DATA+	DATA-	BCK+	BCK-	LRCK-	LRCK+
4	○	●	○	3	DATA-	DATA+	BCK-	BCK+	LRCK-	LRCK+
	●	●	○	4	DATA+	DATA-	BCK-	BCK+	LRCK-	LRCK+
5	○	○	●	5	DATA-	DATA+	BCK+	BCK-	LRCK+	LRCK-
6	●	○	●	6	DATA+	DATA-	BCK+	BCK-	LRCK+	LRCK-
7	○	●	●	7	DATA-	DATA+	BCK-	BCK+	LRCK+	LRCK-
8	●	●	●	8	DATA+	DATA-	BCK-	BCK+	LRCK+	LRCK-

# HDMI I2S Input Diagram

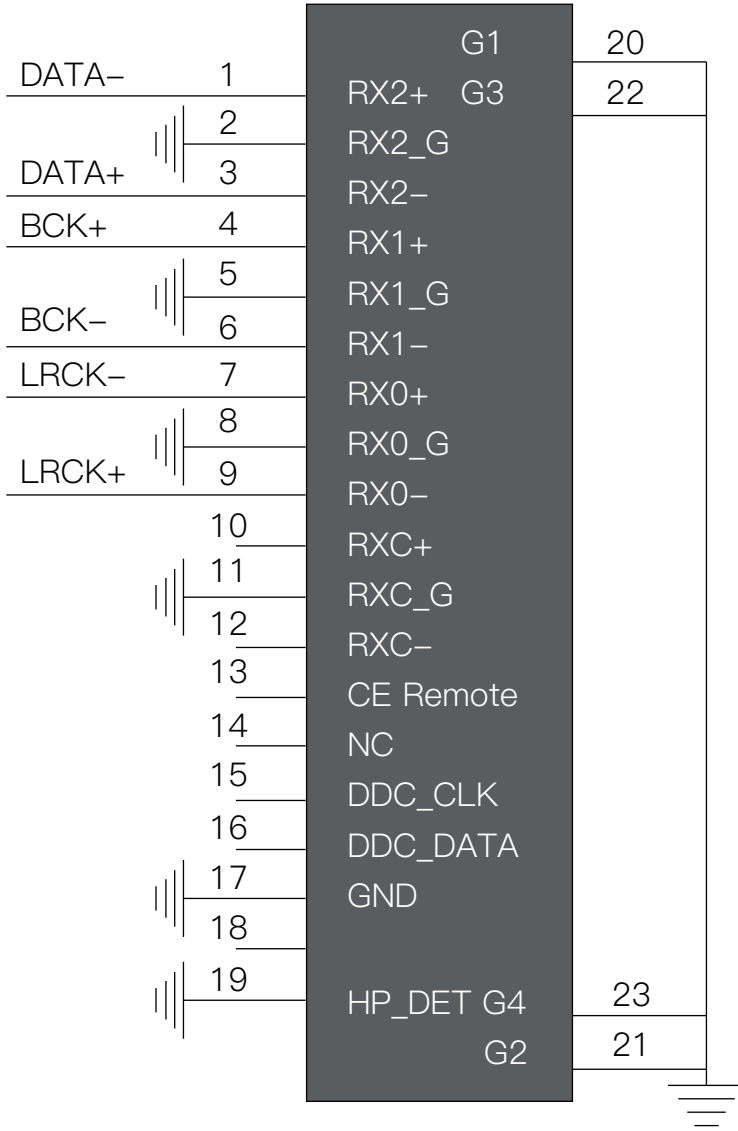



OPT: OPT digital input interface.

I2S–A, I2S–B, I2S–C: I2S (HDMI standard cable) input interfaces. The pinout may vary among different manufacturers. This device offers 8 pinout options to match various manufacturers; please refer to the function settings instructions for details. Note: Do not plug or unplug this cable while the device is powered on, as static electricity may damage the product.

USB: (Universal Serial Bus) interface, the interface provides convenient digital audio transfer, allowing high fidelity audio data transfer for connecting to PCs, Macs, and a variety of digital audio devices.

#### **④. Power Input Connector**



This unit is a Class I device and requires a 3–core power cord, and you need to ensure that the power supply is well grounded; by using the power input connector correctly, you can ensure that the DAC unit receives stable and reliable power support.

# USB Driver Installation

USB Driver Installation – The USB driver is required for Windows operating systems (win10 or above only, for versions below win10 refer to the official website for detailed instructions). The USB driver is licensed by THESYCON and is designed to provide the highest quality audio playback for computer audio systems.

**Note:** Mac and Linux operating systems do not require a USB driver.

## Installation Guide

1. Do not connect the USB cable from your computer to the DAC. unplug it before the USB driver is installed.
2. Download the driver from the support page at <https://www.denafrips.com/download-thesycon>.
3. Double-click the driver on your computer → Follow the on-screen instructions to complete the installation
4. Restart your computer → Connect the USB cable to the DAC → Find the driver icon in the bottom right corner of your computer 
5. Click on the driver icon → select USB Input
6. Click on Playback Devices in the bottom right corner of your computer   
→ Select DENAFRIPS USB DAC as the default sound card for Windows OS.
7. Driver, finish

# Solutions to common faults

Table 4

Phenomenon	Solution
A. No sound output	<ol style="list-style-type: none"><li>1. Check that all input and output connection cables are properly connected.</li><li>2. Check the volume setting of the audio source to ensure that it is not set to mute and that the volume is moderate.</li><li>3. Replace the data cable or cables to ensure there is no damage.</li><li>4. Make sure the input source is the same as the panel selection.</li><li>5. Make sure the unit is not in 'MUTE' state.</li></ol>
B. Noise or murmur	<ol style="list-style-type: none"><li>1. Use the power cord and power adapter to ensure stable power supply.</li><li>2. Check all connecting cables and interfaces to ensure good contact.</li><li>3. Try to avoid placing the DAC in areas with high electromagnetic interference, such as near power lines or wireless devices.</li></ol>
C. sound quality distortion	<ol style="list-style-type: none"><li>1. Make sure the sample rate and format of the input signal match the format supported by the DAC.</li><li>2. Adjust the DAC's filter and decoder settings to select the appropriate sound quality mode.</li><li>3. Check all signal cables and connectors to make sure the connections are firm and undamaged.</li></ol>

Phenomenon	Solution
<p>D. Device cannot be switched on</p>	<ol style="list-style-type: none"> <li>1. Check that the power cord and power adapter are properly connected, and make sure there is power to the power outlet.</li> <li>2. Try restarting the DAC, or reconnecting the power supply after a power failure.</li> <li>3. If the problem persists, you can contact the manufacturer and we provide detailed solutions.</li> </ol>
<p>E. Input signal not recognised</p>	<ol style="list-style-type: none"> <li>1. Ensure that the format and sampling rate of the input signal matches the format supported by the DAC.</li> <li>2. Check the input connector and connecting wires to make sure there is no damage or poor contact.</li> </ol>
<p>F. The computer cannot recognize the USB device.</p>	<ol style="list-style-type: none"> <li>1. Ensure that the latest USB driver for the DAC is installed.</li> <li>2. Check the USB cable and port to make sure the connection is good and undamaged.</li> <li>3. Try replacing the USB cable or using a different USB port.</li> </ol>

# After-sales instructions

1. Thank you very much for choosing DENAFRIPS products. This product comes with a one-year free warranty. During the warranty period, if the product malfunctions due to non-human factors, we will provide free repair or replacement services.

Within Warranty Period: Within one year from the date of purchase, under normal use and non-human damage, if there are any product quality or functional issues.	DENAFRIPS provides free repair or replacement of parts and covers the round-trip shipping costs.
Within the Warranty Period: Within one year from the date of purchase, if any product quality or functional issues occur due to human-caused damage.	The specific charges will be determined based on the actual fault and the cost of replacing parts. Please contact our after-sales service center for a detailed repair quote. The customer is responsible for the round-trip shipping costs.
After the Warranty Period: Paid repair service will be available after the warranty period expires. We will continue to provide repair services for a fee.	Specific charges will be determined based on the actual fault condition and the cost of replacement parts. Please contact our after-sales service center for a detailed repair quote. The customer is responsible for the round-trip shipping costs.

2. The product will not be eligible for free warranty service under any of the following conditions:
- a. The product has exceeded the specified warranty period from the date of purchase.
  - b. The product does not match the model, barcode, or purchase date listed on the warranty card.
  - c. Unauthorized modification or repair of circuits or components by anyone other than DENAFRIPS technicians.
  - d. Damage caused by human factors (such as dropping, impact, water exposure, fire, etc.).
  - e. Damage caused by irresistible natural forces (such as earthquakes, floods, lightning strikes, etc.).
  - f. Damage caused by exceeding the allowed operating environment.
  - g. Damage caused by improper use or storage (including but not limited to: circuit or component burnout due to excessive voltage; damage to the casing or internal components due to impact; damage caused by excessive dust; product oxidation or corrosion, etc.).

3. This warranty policy applies only to customers who purchase products from the official website. For products purchased from distributors, the warranty terms will be governed by the warranty policy established by the seller.

# Important protective measures to be aware of



## warnings



Risk of electric shock inside the unit. Do not open the cover.

- To minimise the risk of electric shock, do not remove the outer cover (or back cover).
- If repairs are necessary, they should be carried out by qualified service personnel.
- To avoid fire and electric shock hazards, do not allow the unit to get wet or damp.

- ①. **Read Protective Measures**—Before using the equipment, carefully read all warning information in the instruction manual regarding protection and operation.
- ②. **Follow the instructions for use**—Please follow the operation and use information in the instruction manual, and do not operate in violation of the instruction manual.
- ③. **Keep away from water and humidity**—Do not place the unit near water, such as bathtubs, washbasins, sinks, washing machines, etc.; and do not use it in high-temperature and high-humidity environments, such as damp basements.
- ④. **cleanse**—Do not use liquid cleaners and mist cleaners, clean with a dry cloth. Unplug the unit before cleaning.
- ⑤. **power supply**—Please use the power supply according to the labelling of the product. The wiring should be arranged reasonably, please do not step on the line, pulling the power cord, so as not to cause damage. Pay special attention to the wires of plugs, convenient sockets and equipment connections.
- ⑥. **Heat Dissipation**—In order to ensure that the product is used reliably, overheating of the device should be avoided, please do not cover cover the device. Do not use the product on surfaces similar to beds, sofas, carpets and other similar surfaces. If the appliance is installed built-in, such as in a bookcase or on a shelf, make sure there is adequate ventilation. Keep a distance of 10cm (4") on each side, above and behind the appliance. The rear edge of the appliance bracket or upper cover should be 10cm(4") away from the rear panel or wall to allow space for ventilation and heat dissipation.
- ⑦. **Thermal energy**—Keep the product away from heat sources such as radiators, stoves, and other objects that generate heat (including power amplifiers).

- ⑧. **Prevent foreign objects or liquids**—Please avoid allowing objects or liquids to enter the device through any openings, as contact with live components may cause a fire or electric shock hazard. Do not place this device in environments where it may be exposed to rain or splashing liquids, and avoid placing containers with liquids (such as vases) on the device.
- ⑨. **Lightning**—During thunderstorms, please unplug the power cord to effectively prevent damage from lightning strikes.
- ⑩. **Protection**—Disconnect the power plug when the product is not used for a long period of time.
- ⑪. **protect and maintain**—Users themselves should not open the device’s shell to avoid electric shock. In the following cases, if you need repair, please contact the official or professional repair outlets to dismantle the machine.
- ⑫. **Disconnecting device**—When the plug, appliance coupler, and power switch are used as the disconnecting device, ensure easy operation.

# DENAFRIPS

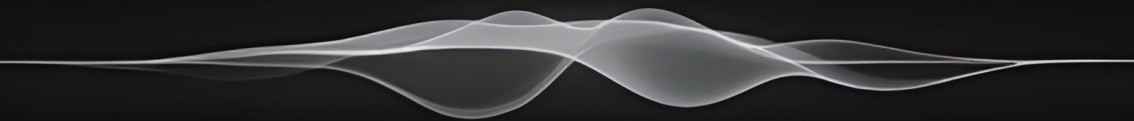

✉ [support@denafrips.com](mailto:support@denafrips.com)

🌐 <https://www.denafrips.com/>

📺 <https://www.youtube.com/@DENAFRIPSAudio>



Facebook